

P-Trap Installation:

9

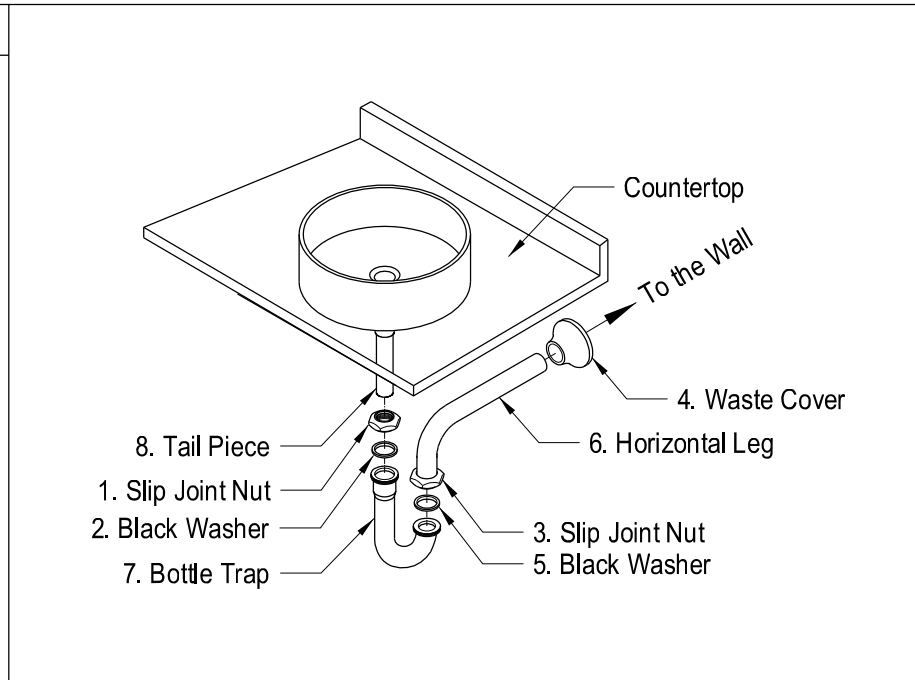

1. Remove horizontal leg and slip joint nut from bottle trap.
2. Apply teflon to all exposed threads.
3. Insert slip joint nut(3) and waste cover(4) onto horizontal leg(6).
4. Insert horizontal leg into wall waste opening, do not tighten.
5. Insert black washer(2) and slip joint nut(1) onto tail piece(8).
6. Attach bottle trap(7) to tail piece and hand tighten slip joint nut(1).
7. Align bottle trap with horizontal leg and tail piece, at this point it may be necessary to cut part of tail piece or part of horizontal leg to obtain proper alignment.
8. After all components have been properly aligned, insert horizontal leg making sure to insert black washer(5) before tightening slip joint nut(3).
9. Thread both slip joint nuts onto bottle trap and tighten along with slip joint securing horizontal leg to wall waste opening.
10. Check for leakage by opening faucet and letting water run for at least 45 seconds.

FAUCETURE[®]
KINGSTON CREATION

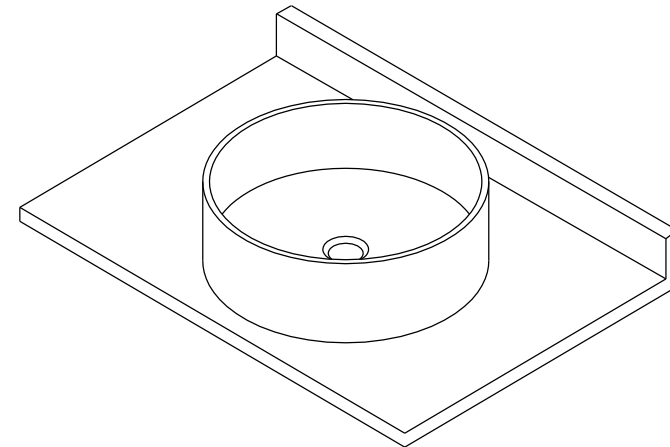
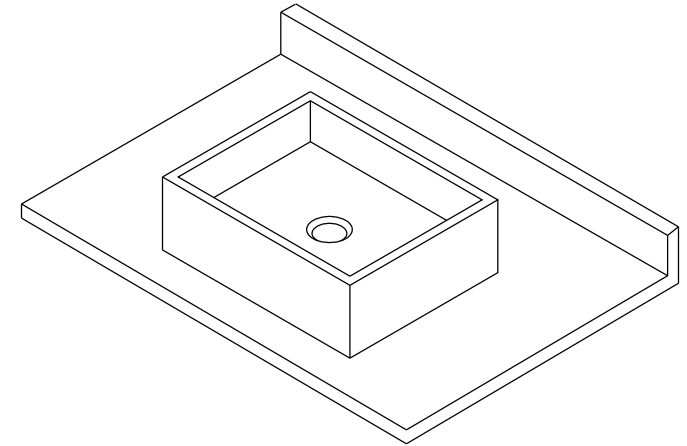

www.kingstonbrass.com

TOLL-FREE CUSTOMER SERVICE: 1-877-2-KBRASS
TECHNICAL SUPPORT E-mail: service@kingstonbrass.com
12775 Reservoir Street, Chino, CA91710

FAUCETURE[®]

KINGSTON CREATION

INSTALLATION INSTRUCTIONS FOR For Use Vessel Sink

1. Prior the installation, unpack your new Kingston Brass product and inspect it keep the product in its original package until you are ready to install it.
2. Shut the water supply off when replacing an existing fixture.
Preparation of the floors and walls, including all additional wall supports, maybe required.
3. Observe all local plumbing and building codes.
4. Do not install this fixture alone.
5. Make sure to select appropriate drain as some of Kingston Brass vessel sinks do not include overflow hole.

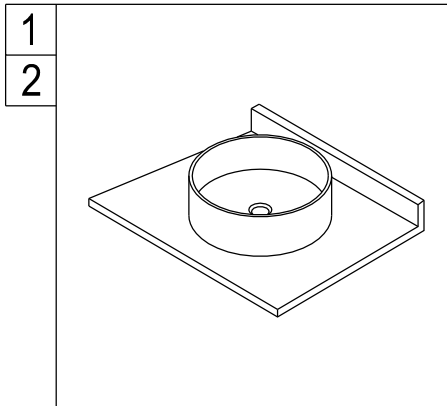

1. Place vessel sink on top of counter where it will be installed.
2. If your vessel sink does not include the faucet hole, then make sure to allow sufficient space for faucet installation.

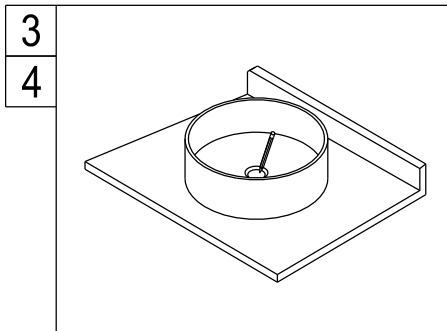

3. Mark location of drain hole.
4. Carefully remove vessel sink.

Need Tools:

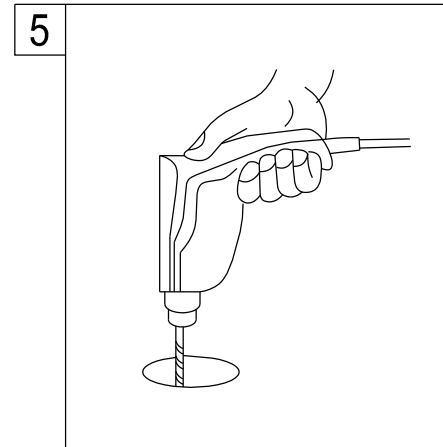
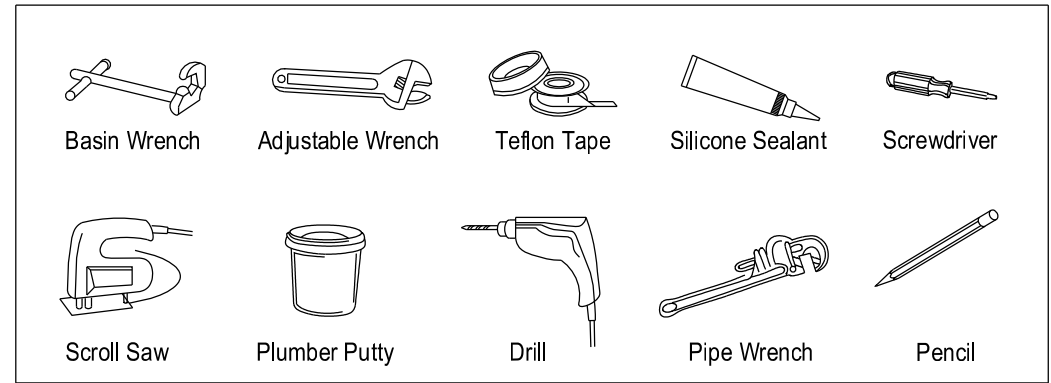

5. Cut a 1-1/2" hole at the previously marked drain location.

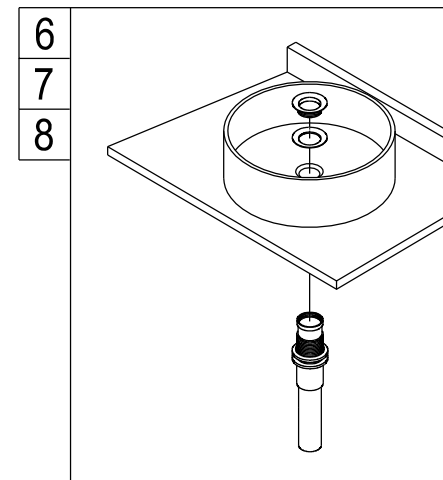

6. Apply a very thin beard of clear caulking around the drain hole.
7. Place vessel sink on counter aligning vessel drain opening with previously drilled drain opening cut out and clean all excess caulking.
8. Insert the drain as show on picture, tighten the drain nut from under the counter and making sure not to over tighten as this may cause cracks in your vessel sink.